

Surtronic® S-100 series

Robust and portable surface roughness testers



Durable roughness testers for shop floor, industrial & inspection room applications

Working closely with manufacturers across a wide range of industries including precision bearings, automotive and aerospace engineering, Taylor Hobson have focused on the key attributes that are most important for quality control in today's precision industries.

The new Surtronic S-100 series of instruments offer a versatile solution for all your roughness requirements with a variety of systems and application specific accessories along with fixtures that can be tailored to your specific need.

USB Connectivity

Through its industry standard Type A USB port and mini USB port the S-100 series instruments provide extensive connectivity options to many standard devices.

USB type A

The Type A USB port can be used to attach a portable printer (ESC/POS compatible), see 'Accessories' page or a standard USB storage device for recording results, raw data or screen images.

USB mini

The mini USB port can be used for charging (with any standard USB charger) and / or connection to a PC to provide further analysis and reporting functionality.

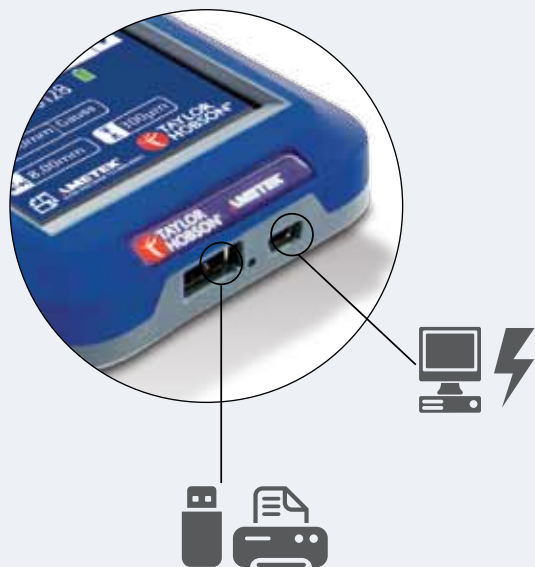

Surtronic® S-100 series

A range of roughness testers robust enough for the shop floor and flexible enough for any inspection room.

Measure

Tactile measurement button, great when device is being used overhead or inside pipes

Lift/lower

Supplied as standard providing 50 mm height adjustment, right angle measurement and 70 mm reach into bores

Anti-slip feet

Perfect for mounting on flat or curved surfaces. V design aligns measurement with cylinder axis

Comfort grip

Sits comfortably in the hand when reviewing results or changing settings

Rubberised moulding

Added protection and better grip in the hand invaluable in shop floor environments



- ✓ Improve throughput
- ✓ Reduce part scrappage
- ✓ Monitor tool wear
- ✓ Ensure traceability

Profile graph

Detailed graph shows measured area to help identify problem areas

Simple set up

Shortcuts provided for all the key settings to give instant access with just a single touch



USB 2.0 type A

attach a portable printer or USB storage device

USB 2.0 mini

for charging (with any standard USB charger) and / or connection to a PC for data transfer

Orientation

Rotate the display to any of 4 orientations – perfect for awkward measurements

Features

Any surface, any height

The inclusion of a 50 mm stylus lift with right-angle attachment and more than 70 mm stylus reach means that even the most challenging surfaces can be measured without the need for expensive riser blocks, stands or fixtures. The anti-slip V-feet also mean the system can be used on flat or curved surfaces. The stylus can even measure upside down!



Standards and traceability

The reference standard supplied can be used both to calibrate the instrument and check for stylus wear to ensure the most accurate results are always being achieved.

Measurement	Best capability
Roughness standards (Ra)	$\pm(2\% + 0.004 \mu\text{m})$
Workpiece or component surface texture (Ra)	$\pm 3\%$ of measured value per trace

UKAS calibration and testing

Taylor Hobson provides full certification for artefacts and instruments in our purpose built ISO graded clean room UKAS facility. Our UKAS laboratory is able to measure all of the parameters associated with surface texture, including French, German, USA and Japanese derivatives.



0026

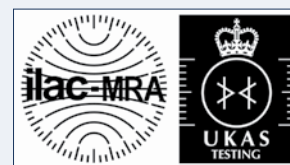

2624

Tough, fast and reliable handheld roughness testers...

Durable roughness testers for shop floor, industrial & inspection room applications



Fast and reliable

Simply press the measurement button and in a few seconds a full set of traceable measurement results including a detailed profile graph will be displayed or printed automatically, printer optional.

Built to last, by design...

Impact resistant rubberised mouldings surround a recessed, Mylar protected high durability touch screen and a solid stainless steel drive mechanism with anti-wear gears and bearings. System power is provided by a 3000 mAh heavy duty Li-Poly battery that can provide up to 2000 measurements from a single charge.

InstantOn

By utilising InstantOn technology these instruments are ready to measure in less than 1 second from standby and fully charged can remain in standby for more than 5000 hours!

In situ measurements

Monitor wear and roughness changes in situ during product's life. Eg. Monitoring changes in turbine blade roughness as an early warning sign for defects and efficiency losses.

User-friendly, not user-hostile!

The Surtronic S-100 series systems are as easy to use as any SatNav (GPS) or SmartPhone with a 4.3" daylight readable industrial touch screen display. Results are displayed with up to 7 parameters per page as well as measurement settings and system information.

<p>Process control Grinding, turning, milling, honing, polishing, extrusion</p>
<p>Automotive Gears, con rods, cylinders, blocks, crankshafts</p>
<p>Heavy industry Shipbuilding, pipelines, sheet steel</p>
<p>Aerospace Turbine blades, turbine shafts, wing composites</p>
<p>Other Print rollers, flooring, bonding</p>

Fully integrated measurement solution

By selecting a Surtronic S-100 series stand and printer (see 'Accessories' page) a fully integrated roughness measurement station can be realized. Roughness measurements can be easily made on multiple parts, results stored internally or on a standard USB memory device and printed to accompany the part to its next stage of manufacture or end user.



TalyProfile

Advanced surface finish analysis

TalyProfile is a dedicated PC based software package designed for use with Surtronic S-100 series instruments. Three versions are available. TalyProfile "Lite" has all functions typically used for a shopfloor inspection, TalyProfile "Silver" has enhanced features for R&W parameters, a statistics module and full report printing and TalyProfile "Gold" has complete laboratory analysis functions:

	Lite	Silver	Gold
Surtronic S-series acquisition	✓	✓	✓
Desktop publishing templates	✓	✓	✓
Multi-language support	✓	✓	✓
EN, FR, DE, ES, IT, PL, CN, KR	✓	✓	✓
Levelling	✓	✓	✓
Symmetries	✓	✓	✓
Zoom	✓	✓	✓
ISO 4287	✓	✓	✓
Material Ratio Curve	✓	✓	✓
Area of a hole/peak	✓	✓	✓
Profile parameters & curves	✓	✓	✓
Roughness & waviness curves	✓	✓	✓
Distance measurement	✓	✓	✓
Multiple file format reports	✓	✓	✓
Report printing	✓	✓	✓
Form Talysurf data import	✓	✓	✓
Tolerance limits (pass/fail)	✓	✓	✓
Data file explorer	✓	✓	✓
ISO 13565 Automotive	✓	✓	✓
Interactive MR curve	✓	✓	✓
Step height measurement	✓	✓	✓
Form removal	✓	✓	✓
Filtering by FFT	✓	✓	✓
Thresholding	✓	✓	✓
Frequency spectrum	✓	✓	✓
Power spectrum density	✓	✓	✓
Retouch profile point	✓	✓	✓
Rk parameters	✓	✓	✓
Rk Parameters curves	✓	✓	✓
ISO 12085 R&W motifs	✓	✓	✓

Outstanding graphics

The software is visually advanced and provides clear on screen profile images. TalyProfile allows the user to take a basic measurement and create a full measurement report using the software's detailed analysis options and desktop publishing function (see screen displays opposite for examples).

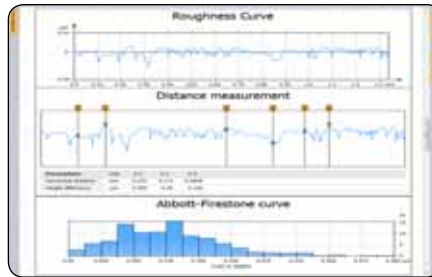

Advanced time-saving analysis templates

A 'template' can be created whereby a sequence of analysis functions can be saved and applied to future measurements, turning detailed reporting tasks into routine documents.

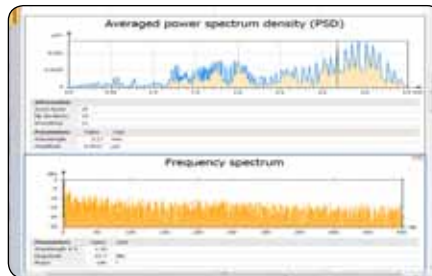

Desktop publishing facility

TalyProfile offers a comprehensive desktop publishing function which allows clear presentation of measurements, results and profiles. Graphs, profiles and results can be arranged from within the TalyProfile software or copied into other wordprocessing documents giving complete flexibility in reporting.

In depth analysis

Profiles can be levelled and zoomed to remove unwanted features or defects from the analysis. Distance measurement between features of a profile are easily achieved and the information can be displayed graphically and numerically. Step height and the area of a valley or peak can also be calculated.

Full compatibility

Surface finish results from other Taylor Hobson surface roughness instruments can be imported to TalyProfile software, allowing a uniform report style to be used throughout your workshop or laboratory

PC specification

	Recommended
Operating system	Windows 7*
Memory (RAM)	3 GB
CPU speed	2 GHz
Screen resolution	1920 x 1080
USB port	2.0

TalyProfile parameters

	Lite	Silver	Gold
ISO 4287			
Rz, Rp, Rv, Rz, Rc, Rt, Ra, Rq, Rsk, Rku, RSm, Rdq, Rmr, Rdc, RPc	✓	✓	✓
Pp, Pv, Pz, Pc, Pt, Pa, Pq, Psk, Pku, PSm, Pdq, Pmr, Pdc, PPc	✓	✓	✓
Wp, Wv, Wz, Wc, Wt, Wa, Wq, Wsk, Wku, WSm, Wdq, Wmr, Wdc, WPc	✓	✓	✓
ISO 13565			
Rk, Rpk, Rvk, Mr1, Mr2	✓	✓	✓
Ppq, Pvq, Pmq	✓	✓	✓
Rpq, Rvq, Rmq	✓	✓	✓
ISO 12085			
R, AR, Rx, Pt, Kr, Nr, SR, SAR	✓	✓	✓
W, AW, Wx, Wte, Kw, Nw, SW, SAW	✓	✓	✓
Trc, HTrc, Rke, Rpke, Rvke	✓	✓	✓
Other 2D Parameters			
PLq, Pda, PLa, PLo, PzJIS, P3z, Pmax, Ptm, Py, PH, PHSC, PD, PS, Pvo, Prms, PTP, PHTp, Pfd, Ppm	✓	✓	✓
RLq, Rda, RLa, RLo, RzJIS, R3z, Rmax, Rtm, Ry, RH, RHSC, RD, RS, Rvo, Rrms, RTP, RHTp, Rfd, Rpm	✓	✓	✓
WLq, Wda, WLa, WLo, WzJIS, W3z, Wmax, Wtm, Wy, WH, WHSC, WD, WS, Wvo, Wrms, WTP, WHTp, Wfd, Wpm	✓	✓	✓
Applicative Parameters			
PG, AF, CH	✓	✓	✓
ASME B46.1			
Rt, Rp, Rv, Rz, Rpm, Rmax, Ra, Rq, Rsk, Rku, tp, Htp, Pc, Rda, Rdq, RSm, Wt	✓	✓	✓
Addon			
MaxHeight, AverageHeight, MinHeight, MaxArea, AverageArea, MinArea	✓	✓	✓



TalyProfile Lite is available to use for FREE. Scan this code to download software from talyprofile.com

Accessories

1 USB Thermal Printer

Compact & highspeed 60 mm (24 in) / second. Includes USB lead and International Power Supply Outputs settings, results, and high resolution graph
code PR-60

2 Thermal Paper – 79 mm width, type. A single unit of paper is 20 x 12.5 metre rolls
code PR-61

3 Column and Stand – Granite base (400 x 250 mm) with manually operated column providing adjustment height of 260 mm
code SA-80

4 Precision Vice – High quality precision vice ideal for holding small components. Jaw width 63 mm, jaw depth 32 mm, jaw opening 85 mm
code SA-31

5 Hard Transport Case – Air and water tight case that provides the Surtronic S100 with extra protection for safe storage and/or transportation.
code SA-54

6 Support Stand – With 4 degrees of freedom. Max measuring height of 430 mm and a range of 115 mm at a horizontal reach of 305–420 mm.
code SA-85

7 Datum Support Stand – Provides an independent straight datum requires pick-up to be fitted with the detachable skid, see below
code SA-90

8 Detachable Skid – For use with Datum Support Stand, clamped to the pick up body, this accessory is required for use with the Datum Support Stand.
code SA-91

9 Pick-up Lift – For controlled lifting and lowering of the pickup to aid measurement setup.
code SA-20

10 Portable Base – Provides a support when used on machine tool applications.
code SA-40

11 S-series Mains Adaptor – International USB charger 5V 1A 110-240VAC 50/60Hz Recharges S116 / S128 in 4 hours
code SC-10

12 Deep Bore Extension Rods Provides extension to pick-up for measurements in deep holes. (100 mm extension) reach 160mm
code SA-25
(200 mm extension) reach 260mm
code SA-28

13 Calibration Standard – Ra 6.0um (236 uin)
code CS-10

14 Dot Matrix Printer – Robust, high speed, high performance, easy-to-use printer with USB connection.
code PR-40

15 Dot Matrix Paper – 76 mm width. A single unit of paper is 10 x 46 metre rolls.
code PR-41

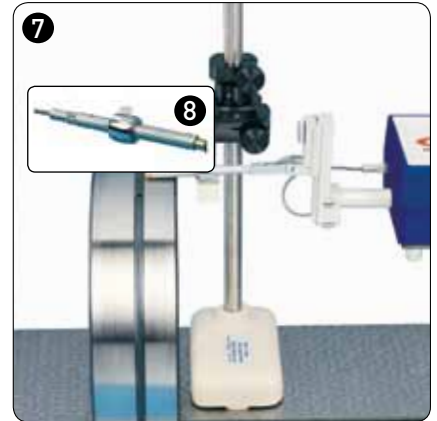

Surtronic S-series dimensions

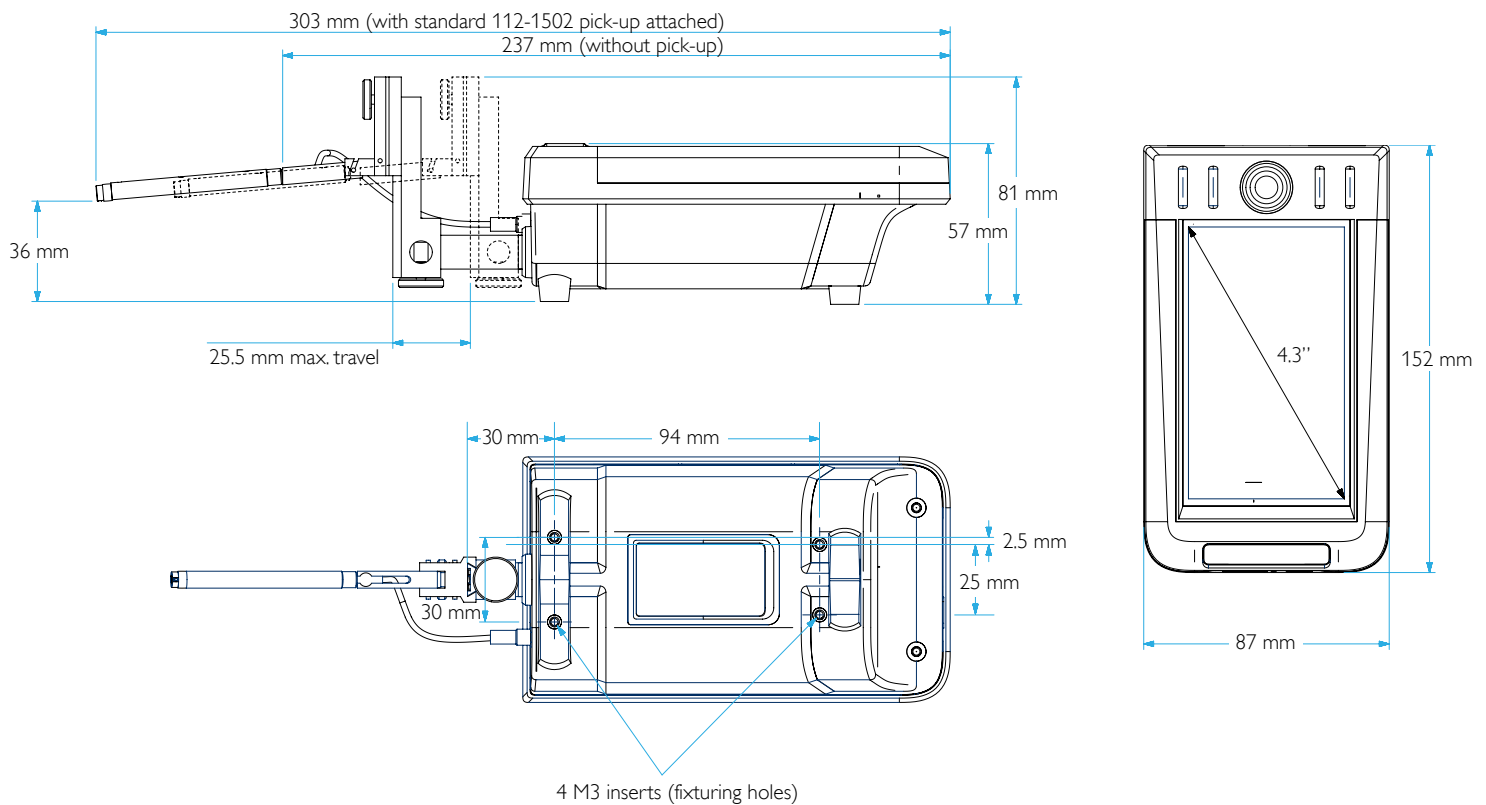

Technical		S-116	S-128
Languages	Basic	English, French, German, Italian, Spanish	
	Extended	Czech, Portuguese, Romanian, Hungarian, Swedish, Russian	
	Asian	Japanese	
Data output	On-screen	up to 7 results per page, selectable on-screen graph with XZ axis	
	Printer	Output settings, results and high resolution profile graph	
	PC Connection	Full data analysis with TalyProfile	
Data storage	Internal	100 measurement results, 1 raw profile	
	USB (4GB supplied)	>39,000 raw profiles, up to 100,000 results per batch (>70 batches)	
	PC connection	Unlimited data storage	
SPC / stats	Internal	Optional	Min, Max, Mean, StdDev of stored results
	USB (4GB supplied)	Optional	ASCII export of all results for SPC
	PC connection	full SPC and tollerancing of all parameters using TalyProfile software	
Battery	Charger	USB 5v 1A 110-240VAC 50/60Hz	
	Charging time	4 hours	
	Battery life	2000 measurements	
	Standby time	5000 hours	
	InstantOn	max 1 sec from standby to ready to measure	
	Auto sleep function	30 sec - 6 hours	

Component capacity		S-116	S-128
Physical specifications	Weight including pickup	0.5 Kg (1.1 lbs)	
	Power source	Li Poly rechargeable battery	
Operating conditions	Temperature	5 - 40 °C (41 - 104 °F)	
	Humidity	0 - 80 % non-condensing	
Storage conditions	Temperature	0 - 50 °C (32 - 122 °F)	
	Humidity	0 - 80 % non-condensing	

Specification

Measurement capability		S-116	S-128
Gauge	Range	200 μm / 100 μm / 10 μm	400 μm / 100 μm / 10 μm
	Resolution	100 nm / 20 nm / 10 nm	50 nm / 10 nm / 5 nm
	Noise floor (Ra)	250 nm / 150 nm / 100 nm	150 nm / 100 nm / 50 nm
	Repeatability (Ra)	1 % of value + noise	0.5 % of value + noise
	Pickup type	Inductive	
	Gauge force	150-300 mg	
	Stylus tip radius	5 μm (200 μin) default / 2 μm (80 μin) or 10 μm (400 μin) optional	
Calibration	Measurement type	Skidded	
	Process	Automated software calibration routine	
	Standards	Able to calibrate to ISO 4287 roughness standards	
Analysis	Filter cut-off	0.25 mm / 0.8 mm / 2.5 mm	
	Filter type	2CR / Gaussian	
	Evaluation length	0.25 mm - 17.5 mm (0.01 in - 0.70 in)	0.25 mm - 25.0 mm (0.01 in - 1.00 in)
	Max X axis range	17.5 mm	25.5 mm
	Speed	Measuring speed	1 mm / sec (0.04 in / sec)
Returning speed		1.5 mm / sec (0.06 in / sec)	

Analysis capability (instrument)		S-116	S-128
Parameters	Standards	ISO 4287, ISO 13565-1, ISO 13565-2, ASME 46.1, JIS 0601, N31007	
	ISO basic	Ra, Rv, Rp, Rz, Rt, Rq, Rsk, Rmr; Rdq, Rpc, RSm, Rz1max	
	ISO advanced	Optional	Rk, A1, A2, Mr1, Mr2, Rpk, Rvk
	ASME	Ra, Rv, Rp, Rz, Rt, Rq, Rsk, Rdq, RSm, Rpm, Rda	
	JIS	Ra, Rv, Rp, Rz, Rt, Rq, Rsk, Rmr; Rdq, RSm, Rz]JIS, Rc, Rku, Rdc	
	Other	R3z (Daimler Benz)	
	ISO Primary	Optional	Pa, Pv, Pp, Pz, Pt, Pq, Psk, Pmr, Pdq, Ppc, PSm, Pz1max
	Units	μm / μin	

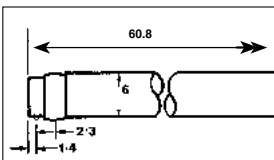

Standard Pick-up
For general surface roughness measurement.
code PK-02 (5 μm tip radius)
code PK-03 (10 μm tip radius)

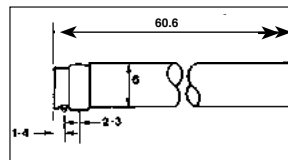

Chisel Edge Pick-up
For measuring along sharp edges or wire. Not for use on flat surfaces.
code PK-24

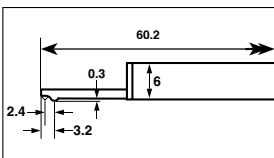

Small Bore Pick-up
For general use in small bores, grooves and on narrow surfaces.
 \varnothing 3.00 mm bore minimum.
code PK-01

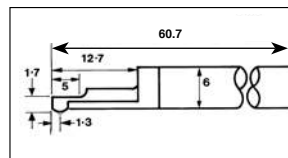

Side Skid Pick-up
For use on curved surfaces such as gear teeth.
code PK-31

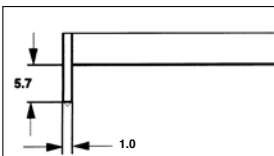

Narrow Gauge Stylus
For measuring in 'O' rings and narrow grooves up to a depth of 5.5 mm (0.22 in).
code PK-07

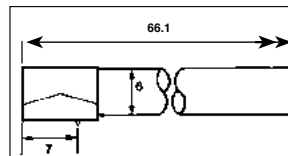

Shoe Pick-up
For measuring rougher surfaces, particularly with the 2.5 mm (0.1 in) cut-off.
code PK-99

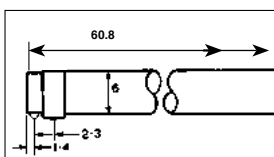

Right Angle Pick-up
For measurement at right angles to the direction of traverse.
code PK-05

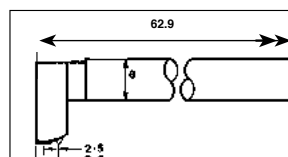

Recess Pick-up
For measuring into deep recesses.
code PK-06 recess 5.7 mm (0.23 in) with 5 μm tip radius
code PK-08 recess 25 mm (0.99 in) with 5 μm tip radius
(Other depths and tip radii available)

Analysis

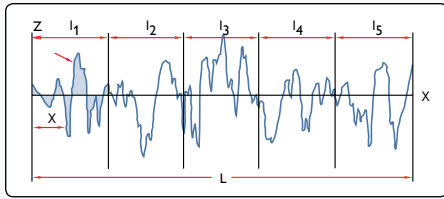

$$Ra = \frac{1}{l} \int_0^l |z(x)| dx \quad Rq = \sqrt{\frac{1}{l} \int_0^l z^2(x) dx}$$

Ra is the most common parameter of roughness. It is the arithmetic mean of the absolute departures from the mean line.

Rq is the rms parameter corresponding to Ra

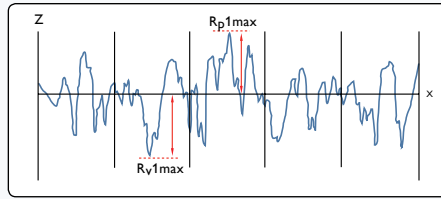

***Rv** is the maximum depth of the profile below the mean line within the sampling length.

***Rp** is the maximum height of the profile above the mean line within the sampling length.

Rt is the maximum peak to valley height of the profile in the assessment length.

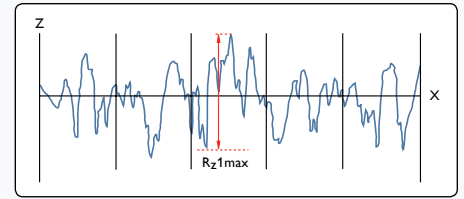

***Rz = Rp + Rv** and is the maximum peak to valley height of the profile within a sampling length.

Rz1max is the largest of the individual peak to valleys from each sample length.

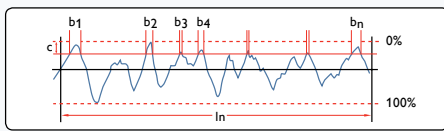

$$Rmr(c) = \frac{b_1 + b_2 + b_3 + b_4 + \dots + b_n}{l_n} \times 100 = \frac{100}{l_n} \sum_{i=1}^n b_i$$

Material Ratio Rmr (c) is the length of bearing surface (expressed as a percentage of the evaluation length) at a depth c below the highest peak.

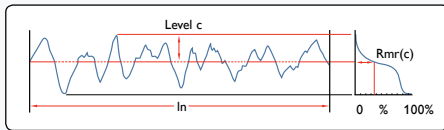

Material ratio curve above, shows how the ratio varies with level.

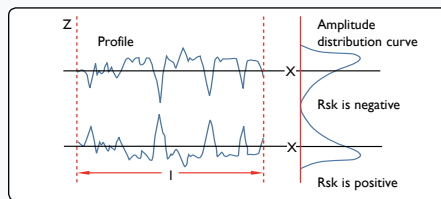

$$Rsk = \frac{1}{Rq^3} \left[\frac{1}{l} \int_0^l z^3(x) dx \right] \quad Rku = \frac{1}{Rq^4} \left[\frac{1}{l} \int_0^l z^4(x) dx \right]$$

Rsk – Skewness – is the measure of the symmetry of the profile about the mean line. It will distinguish between asymmetrical profiles of the same Ra or Rq.

Rku – Kurtosis – is a measure of the sharpness of the surface profile.

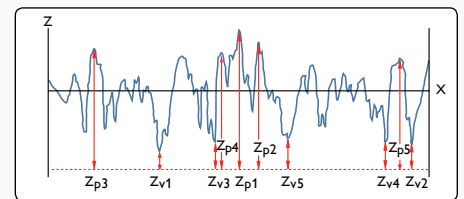

$$Rz(JIS) = \frac{1}{5} \left(\sum_{i=1}^5 Z_{p1} - \sum_{i=1}^5 Z_{v1} \right)$$

Rz (JIS) also known as the ISO 10 point height in ISO 4287/1-1984, it is the average height difference between the five highest peaks and the five lowest valleys within the sampling length.

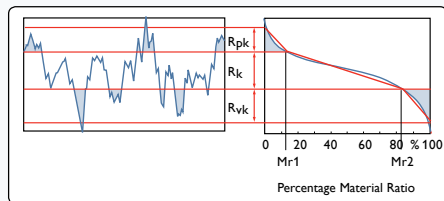

Rpk Reduced Peak Height is the top portion of the surface which will quickly be worn away when the engine begins to run.

Rk Kernel Roughness Depth is the long term running surface which will influence the performance and life of the cylinder.

Rvk Trough Depth is the oil retaining capability of the deep troughs which have been machined into the surface.

Mr1 is Material ratio corresponding to the upper limit of the roughness.

Mr2 is Material ratio corresponding to the lower limit of the roughness.

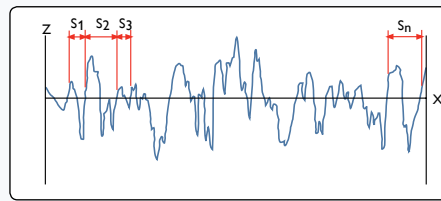

RSm is the mean spacing between profile peaks at the mean line within the sampling length.

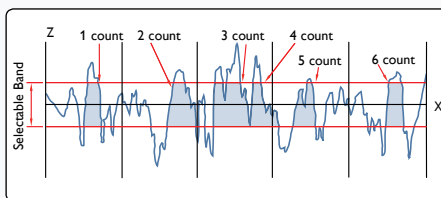

$$R_{Pc} = \frac{\text{Number of counts}}{\text{Assessment length (cm)}} = \text{Peaks/cm}$$

R_{Pc} is the peak count and is the number of local peaks which project through a selectable band centred about the mean line.

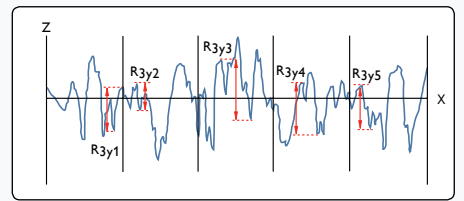

$$R3z = \frac{R3z1 + R3z2 + \dots + R3zN}{N} = \frac{1}{N} \sum_{i=1}^N R3zi$$

R3z is the vertical mean from the third highest peak to the third lowest valley in a sample length over the assessment length. DB N31007 (1983)

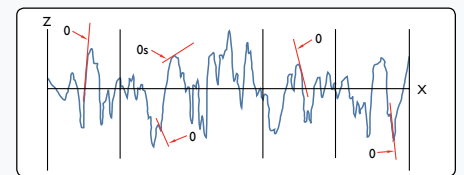

$$R\Delta q = \sqrt{\frac{1}{l} \int_0^l [\theta(x) - \bar{\theta}]^2 dx} \quad \bar{\theta} = \frac{1}{l} \int_0^l \theta(x) dx$$

RΔq is the rms slope of the profile within the sampling length. θ is the slope of the profile at any given point

Surtronic® product range

Surtronic® Duo measures surface roughness at the touch of a button and shows the result on a large colour screen. Cycle time is 5 seconds and the result is saved until another measurement is taken.

- Ready to use out of the box
- Battery life more than 10,000 measurements

Parameters	Range	Resolution
Ra:	40 µm (1600 µin)	0.01 µm (0.4 µin)
Rz, Rv, Rp, Rt:	199 µm (7800 µin)	0.1 µm (4 µin)



IntraTouch measures roughness, waviness and contour. A low cost, portable system for high level surface texture analysis on the shop floor.

- 50mm (1.97in) traverse with straightness datum
- Automatic calibration over a sphere ensures that radius and form measurements are correct

Features	
Gauge range / resolution	16nm @ 1mm range (0.63µin @ 0.04in) / 3nm @ 0.2mm range (0.12µin @ 0.008in)
Straightness accuracy	0.2 µm over any 20 mm (8 µin over any 0.78 in)

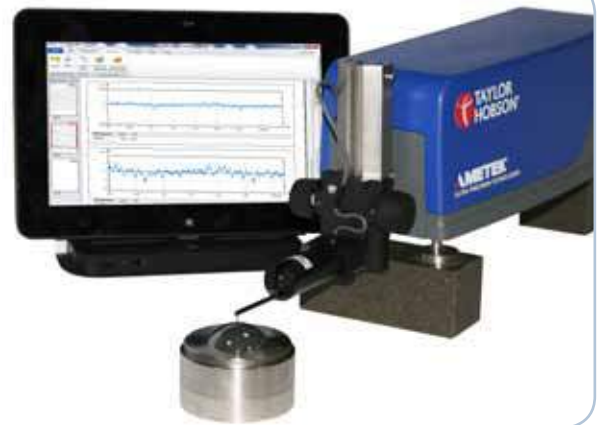

The Surtronic® R-80 is robust enough for the shop floor but accurate for any inspection area, giving a flexible solution for all roundness and form measurements.

- Patented gauge orientation
- Robust enough for 24/7 operation
- Easy-to-use touchscreen software

Feature	
Gauge resolution	30 nm (1.18 µin)
Spindle accuracy	±25 nm (0.98 µin)

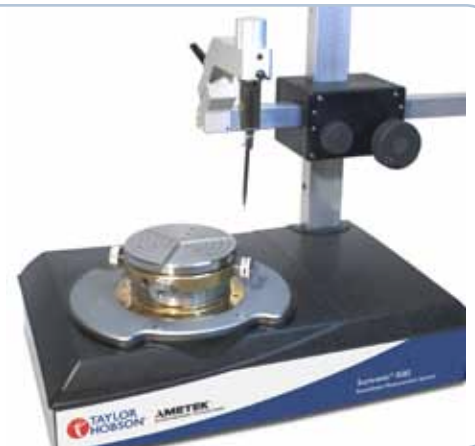

Surtronic® R-100 Series builds on the robustness and ease-of-use of the R-80, offering a higher throughput and improved feature set that includes advanced harmonic analyses and a higher gauge resolution.

- Robust, fast and easy-to-use
- Includes Rapid Centre™ *
- Throughput 3 parts / minute including set-up

Feature	
Gauge resolution	6 nm (0.24 µin)
Spindle accuracy	±25 nm (0.98 µin)



* Centering attachment is supplied as standard with R-120/125 models, or available to purchase as an accessory on other models.

The metrology experts

Taylor Hobson is world renowned as a manufacturer of precision measuring instruments used for inspection in research and production facilities. Our equipment performs at nanometric levels of resolution and accuracy.

To complement our precision manufacturing capability we also offer a host of metrology support services to provide our customers with complete solutions to their measuring needs and total confidence in their results.

www.taylor-hobson.com

Sales department

Email: taylor-hobson.sales@ametek.com
 Tel: +44 (0)116 246 2034

- **Design engineering** – special purpose, dedicated metrology systems for demanding applications
- **Precision manufacturing** – contract machining services for high precision applications and industries

Service department

Email: taylor-hobson.service@ametek.com
 Tel: +44 (0)116 246 2900

- **Preventative maintenance** – protect your metrology investment with an Amecare support agreement

Centre of Excellence department

Email: taylor-hobson.cofe@ametek.com
 Tel: +44 (0)116 276 3779

- **Inspection services** – measurement of your production parts by skilled technicians using industry leading instruments in accord with ISO standards
- **Metrology training** – practical, hands-on training courses for roundness and surface finish conducted by experienced metrologists
- **Operator training** – on-site instruction will lead to greater proficiency and higher productivity
- **UKAS calibration and testing** – certification for artifacts or instruments in our laboratory or at customer's site

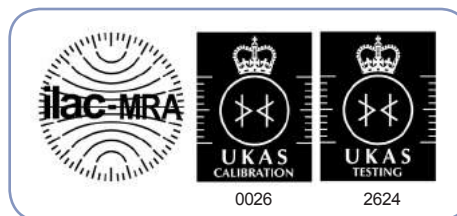

Copyright© 2016 · Taylor Hobson
 Surtronic S100 Series_02/2016



Taylor Hobson UK

(Global Headquarters)
 PO Box 36, 2 New Star Road
 Leicester, LE4 9JD, England
 Tel: +44 (0)116 276 3771
 Fax: +44 (0)116 246 0579
taylor-hobson.sales@ametek.com



Taylor Hobson China

taylor-hobson-china.sales@ametek.com.cn
Shanghai Office
 Part A1, A4, 2nd Floor, Building No. 1, No. 526
 Fute 3rd Road East, Pilot Free Trade Zone,
 Shanghai, 200131, China
 Tel: +86 21 5868 5111-110
 Fax: +86 21 5866 0969-110
Beijing Office
 Western Section, 2nd Floor, Jing Dong Fang
 Building (B10), No. 10, Jui Xian Quio Road,
 Chaoyang District, Beijing, 100015, China
 Tel: +86 10 8526 2111
 Fax: +86 10 8526 2141
Chengdu Office
 Unit 9-10, 10th Floor 9/F, Hi-tech Incubation
 Park, No.26 West Jinyue Road, Chengdu.
 610041, China
 Tel: +86 28 8675 8111
 Fax: +86 28 8675 8141
Guangzhou Office
 Room 1412, Yi An square, No.33 Six
 Construction Road, Guangzhou, 510060, China
 Tel: +86 20 8363 4768
 Fax: +86 20 8363 3701



Taylor Hobson France

Rond Point de l'Epine Champs
 Batiment D, 78990 Elancourt, France
 Tel: +33 130 68 89 30
 Fax: +33 130 68 89 39
taylor-hobson.france@ametek.com



Taylor Hobson Germany

Rudolf-Diesel-Straße 16
 D-64331 Weiterstadt, Germany
 Tel: +49 6150 543 0
 Fax: +49 6150 543 1502
taylor-hobson.germany@ametek.com



Taylor Hobson India

1st Floor, Prestige Featherlite Tech Park 148,
 EPIP II Phase, Whitefield, Bangalore - 560 006,
 India
 Tel: +91 18 6026 62468
 Fax: +91 80 6782 3232
taylor-hobson.india@ametek.com



Taylor Hobson Italy

Via De Barzi, 20087 Robecco sul Naviglio,
 Milan, Italy
 Tel: +39 02 946 93401
 Fax: +39 02 946 93450
taylor-hobson.italy@ametek.com



Taylor Hobson Japan

3F Shiba NBF Tower, 1-1-30, Shiba Daimon
 Minato-ku, Tokyo 105-0012, Japan
 Tel: +81 36809 2406
 Fax: +81 36809 2410
taylor-hobson.japan@ametek.com



Taylor Hobson Korea

#309, 3rd FL, Gyeonggi R&DB Center, 105,
 Gwanggyo-ro, Yeongtong-gu, Suwon-si,
 Gyeonggi-do, Korea, 16229
 Tel: +82 31 888 5255
 Fax: +82 31 888 5228
taylor-hobson.korea@ametek.com



Taylor Hobson Mexico

Acceso III No. 16 Nave 3 Parque Ind. Benito
 Juarez Queretaro, Qro. Mexico C.P.76120, Mexico
 Tel: +52 442 426 4480
 Fax: +52 442 295 1987
taylor-hobson.mexico@ametek.com



Taylor Hobson Singapore

AMETEK singapore, 10 Ang Mo Kio Street 65,
 No. 05-12 Techpoint, Singapore 569059
 Tel: +65 6484 2388 Ext 120
 Fax: +65 6484 2388 Ext 120
taylor-hobson.singapore@ametek.com



Taylor Hobson Taiwan

10F-5, No.120, Sec. 2, Gongdao Wu Rd.,
 Hsinchu City 30072, Taiwan
 Tel: +886 3 575 0099 Ext 59
 Fax: +886 3 575 0799
taylor-hobson.taiwan@ametek.com



Taylor Hobson USA

1725 Western Drive West Chicago,
 Illinois 60185, USA
 Tel: +1 630 621 3099
 Fax: +1 630 231 1739
taylor-hobson.usa@ametek.com